

Technical sheet :

MLA 5-50 H



Capacities		Metric
Static tipping load with bucket (straight)		1880 kg
Static tipping load with bucket (full tum)		1650 kg
Static tipping load with forks (straight)		1470 kg
Static tipping load with forks (full tum)		1295 kg
Max. height of bucket pivot point	h35	3070 mm
Weight and dimensions		
Unladen weight (with forks) with 4-post canopy		2678 kg
Wheelbase	y	1770 mm
Overall cab width	b4	991 mm
Overall height with 4 posts canopy	h38	2290 mm
Dump reach - Full height	r6	458 mm
Hood Height	h40	1469 mm
Overall Operating Height - Fully Raised	h27	3870 mm
Articulation angle	a19	40 °
Maximum oscillation angle		10 °
Overall length with bucket	l16	4490 mm
Overall width less bucket	b1	1330 mm
Overall length - Less Bucket	l2	3792 mm
Rear overhang	c6	1146 mm
Dump angle - Fully raised	a5	47 °
Dump Height - Fully Raised	h29	2301 mm
Maximum Rollback Angle - Fully Raised	a4	46 °
Maximum Rollback Angle at Ground	a13	50 °
Digging Position	h32	-72 mm
Ground clearance	m4	356 mm
Clearance Radius - Front with Bucket	b18	3361 mm
Clearance Radius - Less bucket	b14	2888 mm
Ground Plane to Bucket Edge Height	h42	2837 mm
Tread width (wheel center)	b29	946 mm
Attachment Pivot Clearance	d6	168 mm
Height from ground to axle center	m8	230 mm
Bucket Width	e1	1520 mm
Front Wheel Center to Pivot Pin	m3	733 mm
Engine		
Engine brand		Perkins
Engine model		403J-E17T
Number of cylinders		3
I.C. Engine power rating / Power (kW)		48 Hp / 36 kW
Max. torque / Engine rotation		166 Nm / 1600 rpm
Engine cooling system		Water
Transmission		
Transmission type		Hydrostatic
Number of gears (forward / reverse)		2 / 2
Max. travel speed (may vary according to applicable regulations)		20 km/h
Service brake		Inching Brake
Hydraulics		
Hydraulic pump type		Gear pump
Hydraulic flow - Pressure		60 l/min / 207 Bar
High-Flow Option (l/min)		60 l/min
Tank capacities		
Hydraulic oil		50 l
Fuel tank		65 l

MLA 5-50 H - Dimensional drawing

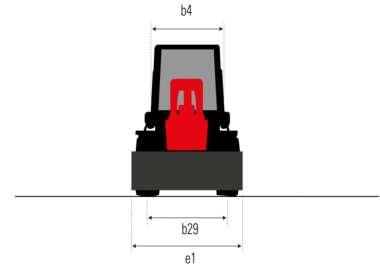
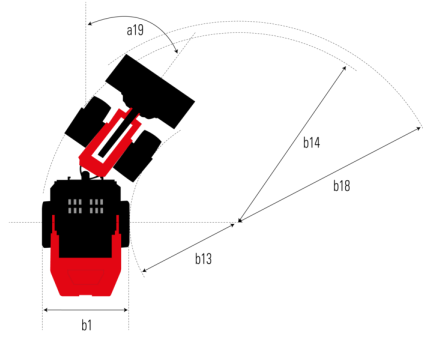
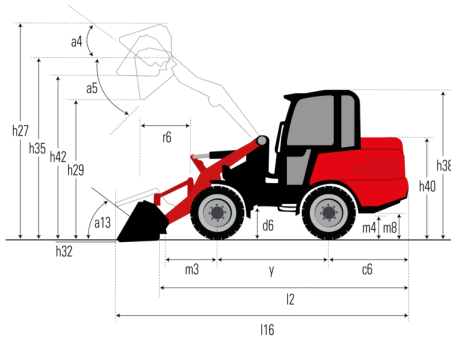



Siège Social

430 rue de l'Aubinière - 44150 Ancenis Cedex - France

Tel: +33(0)2 40 09 10 11 - Fax: +33 (0)2 40 09 10 97

www.manitou.com



This brochure describes versions and configuration options for Manitou products which may be fitted with different equipment. The equipment described in this brochure may be standard, optional or not available depending on version. Manitou reserves the right to change the specifications shown and described at any time and without prior warning. The manufacturer is not liable for the specifications given. For more information, contact your Manitou dealer. Non-contractual document. Product descriptions may differ from actual products. List of specifications is not comprehensive. The logos and visual identity of the company are the property of Manitou and may not be used without authorisation. All rights reserved. The photos and diagrams contained in this brochure are provided for information only.

MANITOU BF SA - Limited company with board of directors - Share capital: 39,668,399 euros - 857 802 508 RCS Nantes